

VOORAANZICHT - VUE FRONTALE
VORDERANSICHT - FRONT VIEW

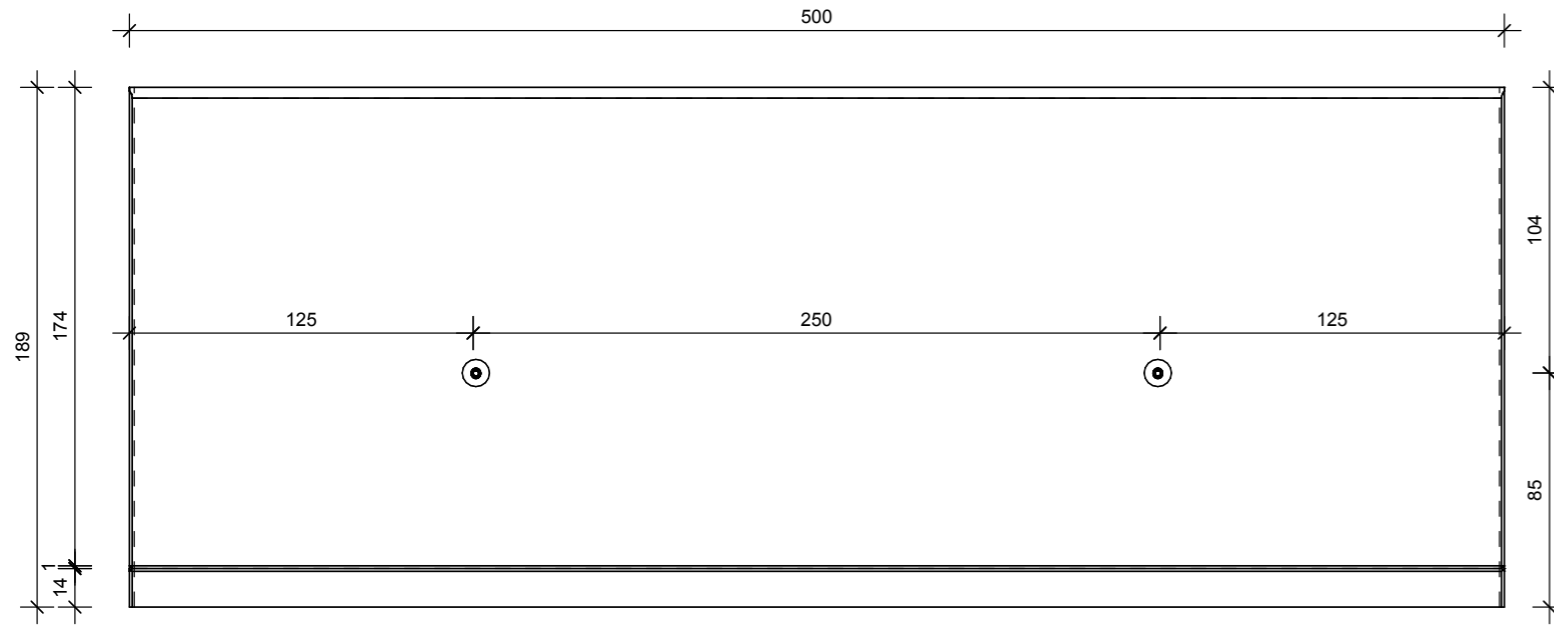

DOORSNEDE - COUPE TRANSVERSALE
QUERSCHNITT - CROSS SECTION

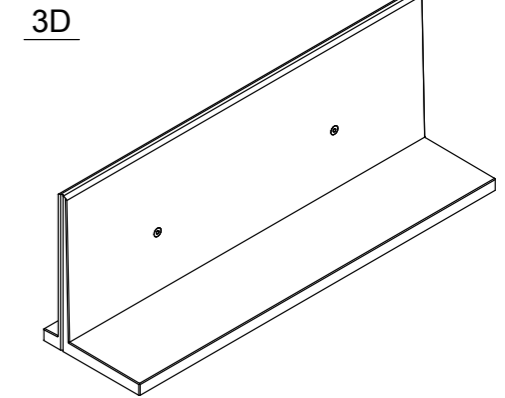
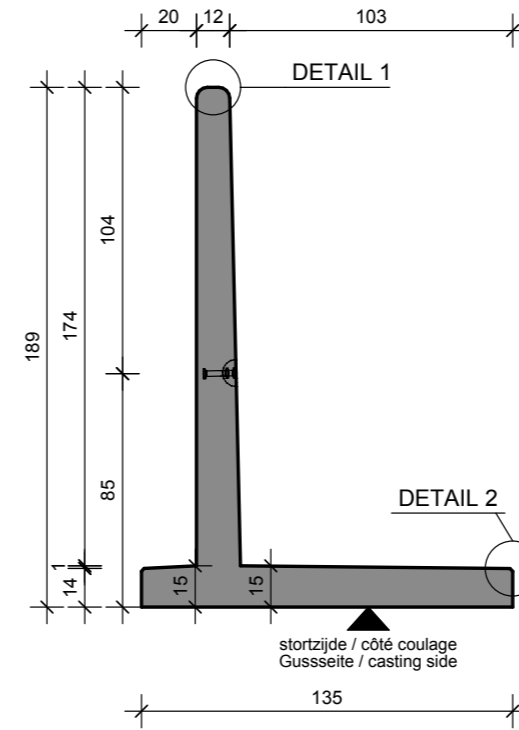

BOVENAANZICHT - VUE SUPERIEURE
DRAUFSICHT - TOP VIEW

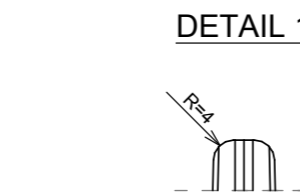
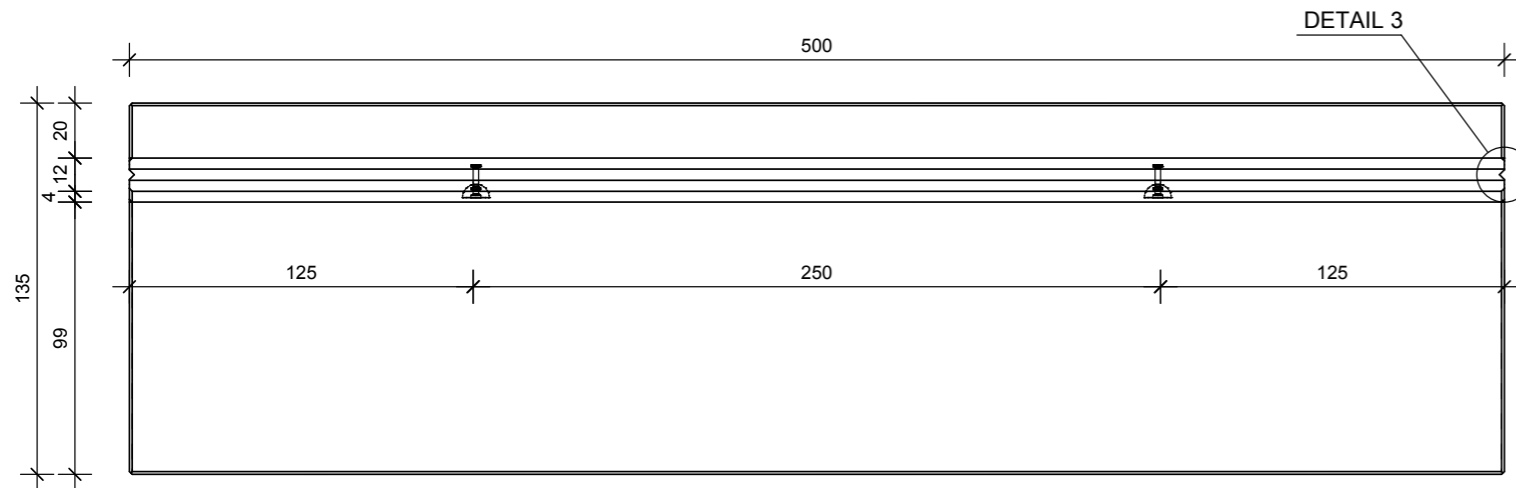

DETAIL 2

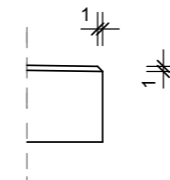

DETAIL 3

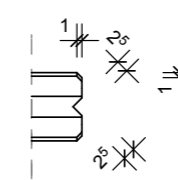

Opmerking:
Betonmaten in cm. Overige maten in mm.



TECHNISCHE FICHE / FICHE TECHNIQUE
TECHNISCHE DATEN / TECHNICAL DATA

element / élément / Element / element

CLAGRI 189x500

sterkteklasse / classe de résistance Festigkeitsklasse / strength class	C60/75	artikelnr. / numéro d'article Article nr. / item number	10366
sterkte bij levering / résistance lors de la livraison Festigkeit bei Lieferung / strength at delivery	/	versie / version Version / version	20190717
betondekking / enrobage de béton Betondeckung / concrete cover	30mm	productie / production Herstellung / production	Emmen / Wielsbeke
milieuklasse / classe d'exposition Expositionklasse / exposure class (EN 206)	XC4, XF1, XA3	volume / volume Volumen / volume	2.19 m ³
constructieklasse / classe structurelle structural class	S1	gewicht / poids Gewicht / weight	5440 kg
staalkwaliteit / qualité de l'acier Stahlgüte / steel quality	B500B	ankers / ancrés Anker / anchors	RTA: / 2x KKA 50/120

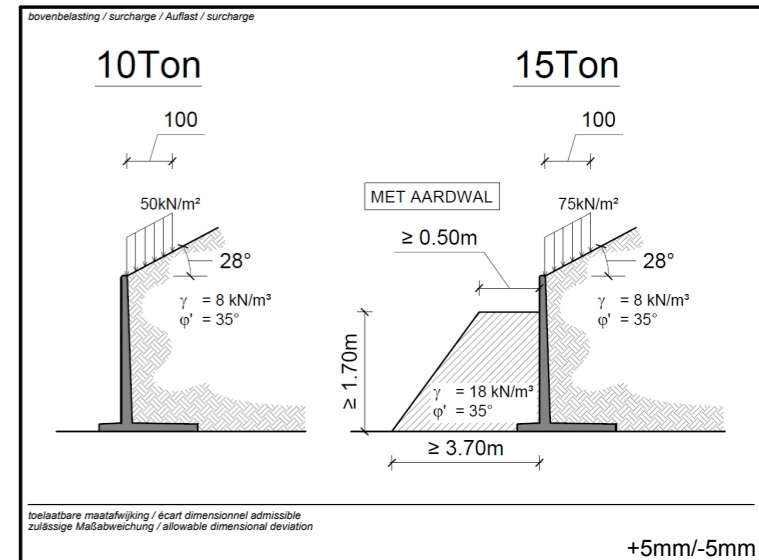

MBS & CBS Beton BV
Phileas Foggstraat 24D
NL-7825 AK Emmen

Tel. +31 05 91 742 010

info@mbs-cbsbeton.nl
www.mbs-cbsbeton.nl